

The Dolls House Emporium

Distributed by Streets Ahead Dollshouse.

PL7 4JH, United Kingdom.

website: www.dollshouse.com

e-mail: products@dollshouse.com

CLASSICAL DOLLS HOUSE *QuickStyle* KIT INSTRUCTIONS

Unpack your kit and study the contents carefully, relating the parts to the contents list and drawings. In the unlikely event of there being a missing or broken part then please ring **0845 434 9201** and our staff will ensure that the problem is dealt with promptly.

We recommend that all Dolls House Emporium kits are dry built first. Please read through all the instructions carefully before commencing. If, at any stage you would like any advice or assistance, please ring us on **0845 434 9202** and we will be pleased to answer any queries.

It is not recommended to keep your dolls house in a conservatory - due to the extremes of temperature.

CLASSICAL DOLLS HOUSE *QuickStyle* KIT PARTS not to scale

When requesting a missing or damaged part please prefix part number with 1034



End Walls
A1, A2



Base A3

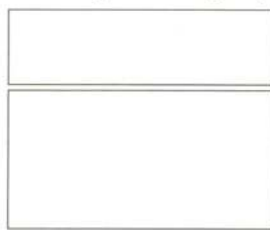

Large back panel B1
Small back panel B2

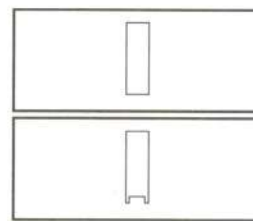

Upper mid floor C2
Lower mid floor C1

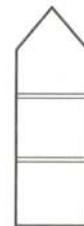

Mid walls
D1 (x2)

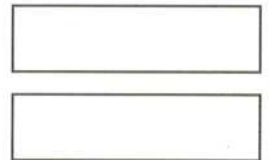

Roof panels E1, E2

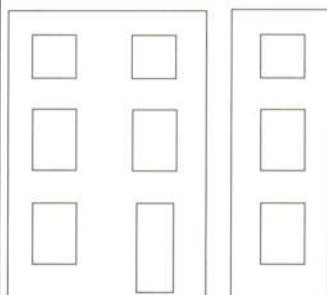

Large front panel F1
Small front panel F2



Door step
F11

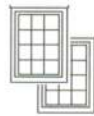

Medium Windows
(x5 sets) W1



Door and Frames
(1 set) and
Architrave W3



Small Windows
(x3 sets) W4



Plastic porticos
(x6) G1 OR
Wooden porticos
(x6) W2

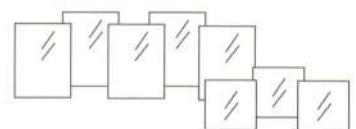

Medium acetate sheets for
windows (x10) F7 Small acetate
sheets for windows (x6) F8

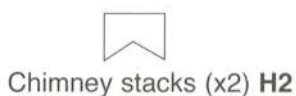

Chimney stacks (x2) H2



Chimney Pots (x4) H4



Large flat column (x2) F12

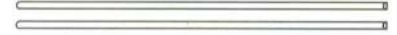

Half round columns F13



Chimney Caps
(x2) H3



Curved Scotia
for portico F15



Curved
Scotia F10



Stairways
(x2) X1



Brassed hinges (x4) H1



Portico
Cappings F16



Gap Stick F19

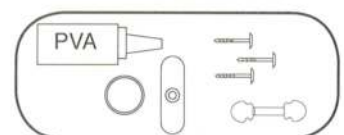

Bag of bits containing:
magnet and striking plate,
screws, brass door knob,
PVA glue. F18

TOOLS AND MATERIALS REQUIRED

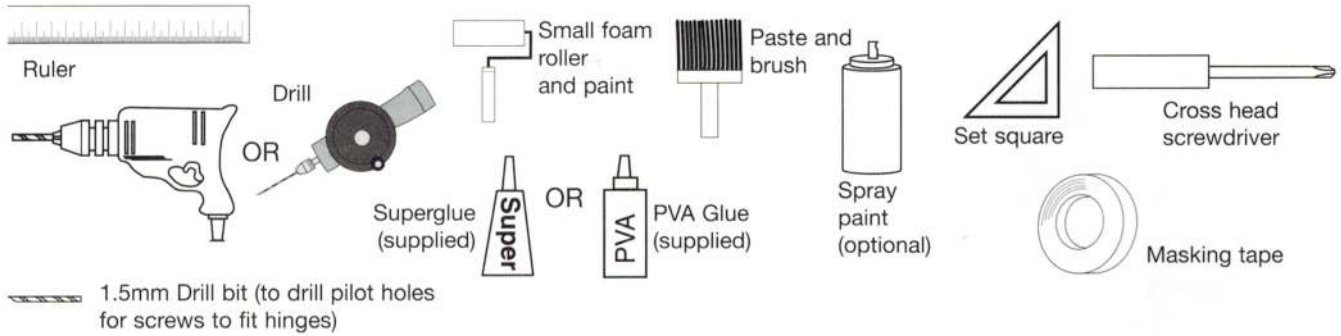

Safety First - Wear goggles and a mask when cutting or sanding MDF

DRY ASSEMBLY

We recommend that all Dolls House Emporium kits are dry built first, to ensure all the parts fit together properly before gluing and so that the instructions are fully understood. Use masking tape to hold panels together whilst dry building. After unpacking your dolls' house kit, do not throw away the box. Opened up and flattened out, it can be used to cover your work surface (secured with masking tape). It will protect both your work surface and the painted surfaces of your dolls' house.



GLUING TIPS

PVA wood glue and superglue are supplied in the kit. It is advised that PVA is used to glue larger parts, such as the carcass and superglue is used for smaller painted parts and plastics. It is indicated which glue to use in the instruction steps.

PVA: Always shake PVA before use. Apply plenty of glue in a zig zag motion down the groove and ensure the glue is evenly spread. When using PVA to join painted surfaces, an ideal bond can be achieved by sanding to create a key on the two parts that are to be joined. Excess glue should be wiped away using a damp cloth.

Superglue: When gluing parts onto painted surfaces, we recommend using the superglue. If superglue doesn't stick to an absorbent surface, let the glue dry, then re-apply. The first coat will have sealed the surface and the second coat will stick. If superglue doesn't stick to a shiny surface, sand it lightly to provide a key. If you stick your fingers together with superglue, soak them in hot water and washing-up liquid, and gently prise them apart.

To add pressure during gluing stages stand heavy weights in strategic positions.

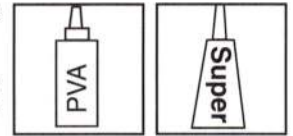

PAINTING TIPS

To get the best results, seal the MDF parts with an MDF sealer (available from DIY outlets) or 50/50 water and PVA before painting and decorating. Oil based matt finish is ideal, applied with a small foam roller for a flat and even finish. Gloss paint for details can also be used. British Standard codes are as follows:

Classical Blue Eggshell: **BS 18 E 50**
 Country Store, Queen Anne, Priory & Fairbanks Cream Eggshell: **BS 10 C 31**
 Kate's Cottage & Malibu Beach House White: **BS 08 B 15**
 Mornington Mews Lavender: **BS 05 9 33**
 Mornington Mews & Mackintosh White: **BS 10 B 15**

Paints can be obtained from:
Trimite 01895 251234
Dulux 01753 550555
Crown/Brolac 01254 704951
 or your local decorators' merchant

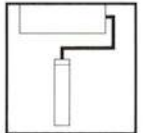

Wooden windows and doors can be coated with a spray paint for a flat and even finish, varnished or stained.

For a realistic pebble-dash finish on your exterior walls, buy a tester pot of masonry paint in the colour of your choice and add some fine sand. Two coats will produce a very pleasing effect.

WALLPAPERING TIPS

Check the walls for any lumps and bumps before papering. Allow minimal overlap when cutting wallpaper. This will make the job of applying it much easier. In fact, if skirting boards and/or coving are to be fitted, no overlap is necessary. It is often easier to decorate the house with it lying on its back. Gravity will help in the positioning of the wallpaper. A 2-inch soft-bristled brush and a 2-inch paint scraper are helpful tools for wallpapering into corners, giving a professional finish. It is easier to wallpaper the roof before attaching it to the house. For cutting difficult shapes in wallpaper, first use a piece of scrap paper to make a template. You can mark this paper by pushing it into the corners of the house and making creases in it. When you are happy with the fit, transfer the shape to your wallpaper.



To achieve an ideal bond first size walls with a 50/50 water and PVA glue mix, then when this is dry, put on the wallpaper as usual with wallpaper paste. If panels are painted then an ideal bond is achieved by lightly sanding the shiny finish (to give a little more key to the surface) before sizing and wallpapering. If, after wallpapering, you find that you have an air bubble in it, use a hair dryer to shrink back the wallpaper. If this does not work, wet the paper and use the hair dryer again. Use ordinary wallpaper paste, available from DIY stores and interior decorating suppliers.

WIRING INFORMATION

There is a suggested wiring circuit layout at the end of these instructions, and full details are given with the wiring kit.

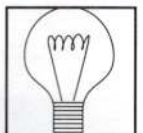

CONSTRUCTION

1



Dry build your kit now using masking tape and mark up correct orientation of stairs

NB: Whilst you dry build the kit, it is an ideal time to mark the panels and parts (lightly with pencil) that you wish to paint or treat before construction (eg. ceiling, scotia strips, porticos, windows, doors etc).

Also we suggest that you work out the best time to decorate the various other parts in the kit. We recommend you do this during a dry build; a good idea is to create a list of what to do and when for tasks such as papering rooms before putting the floors/ceilings in, fitting doors, installing lights, carpeting floors etc. When you have done this, run through the steps during another dry build to check your order will work.

This will give you more chance to become accustomed to the kit and can save a great deal of time and mistakes in the long run.

Warning: Do not use masking tape on pre-papered surfaces.

Happy building !

2



Apply glue to base (A3) as shown.

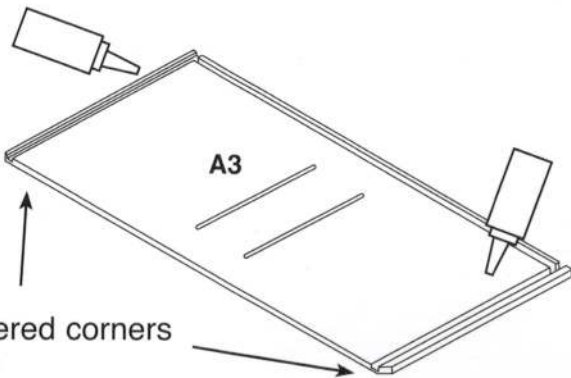

Chamfered corners at front

3

Important to line up grooves

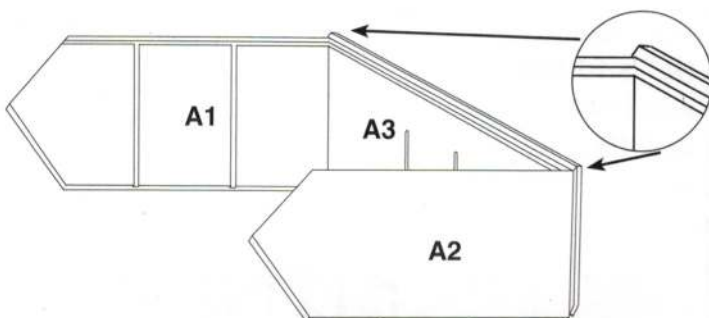

4

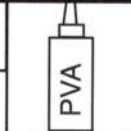

Locate side walls (A1 and A2). Apply glue into back groove in base and side wall as shown.

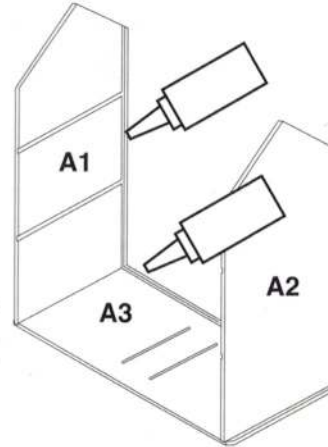

5



Locate small back panel (B2) and slot into grooves. Apply glue to top edges of small back panel and side grooves as shown.

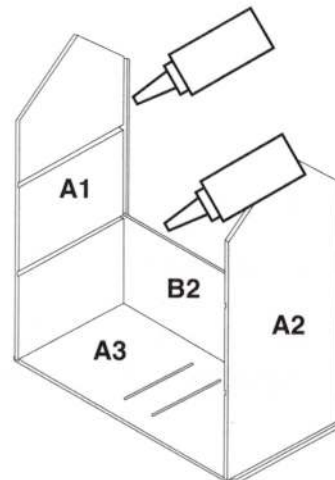

6

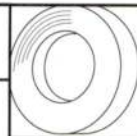

Locate large back panel (B1) and slot into grooves. Ensure carcass is square, use masking tape to hold panels in position while drying and during construction.

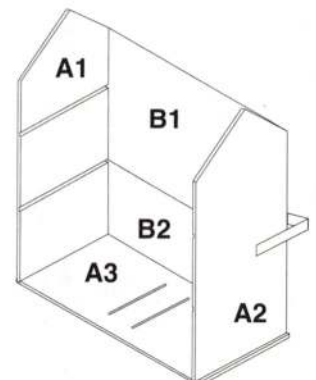

7



Apply glue as shown.

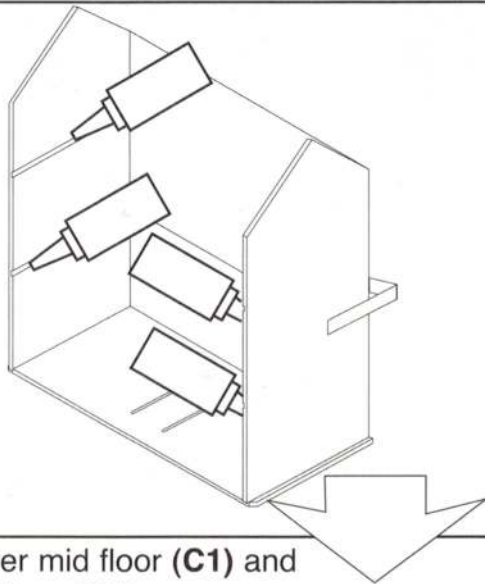

8

Locate lower mid floor (C1) and upper mid floor (C2).

Pencil mark indicating side of floor to face up.

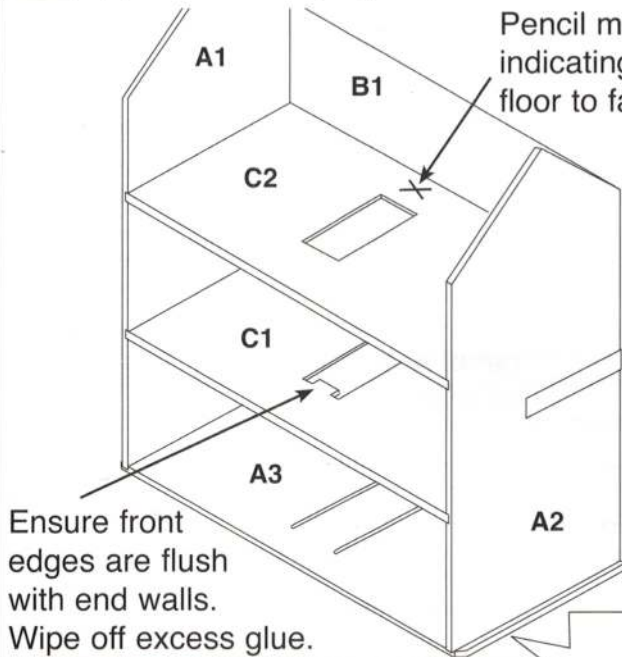

Ensure front edges are flush with end walls. Wipe off excess glue.

9

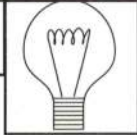

Install hanging lights to C1 and C2 only at this stage, if required. (See wiring instructions for full details)

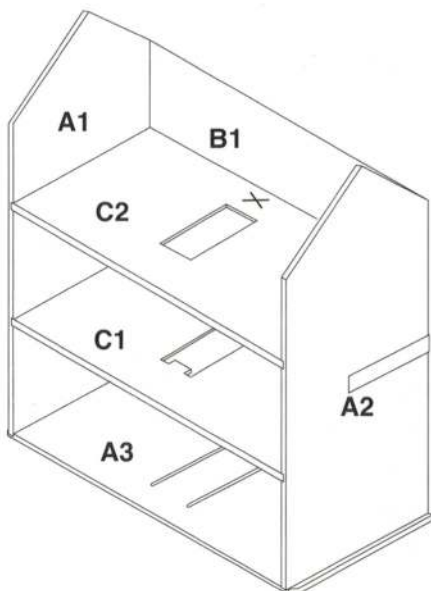

10



Apply glue to grooves on mid walls (D1) and base (A3) as shown.

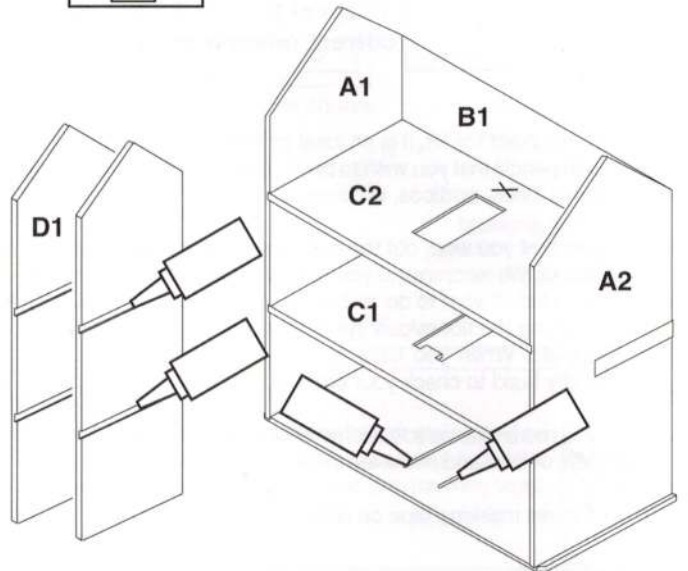

11

Locate mid walls (D1), slots facing outwards.

To ensure a good bond insert stairway (do not glue) in between mid walls and twist. Remove stairs when dry.

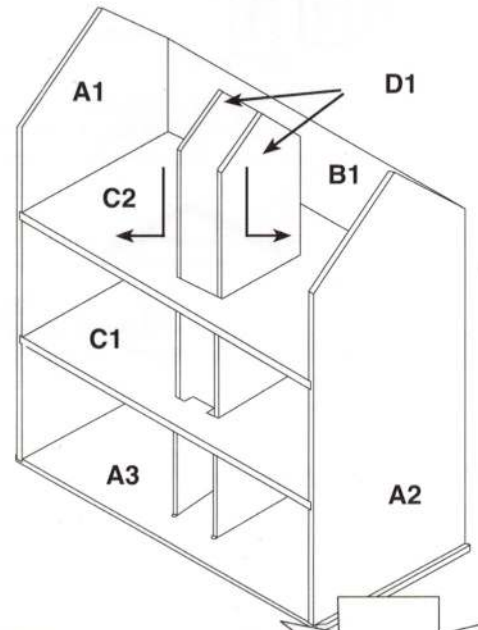

12



Apply glue to top of side walls (A1 and A2) and back wall (B1) as shown.

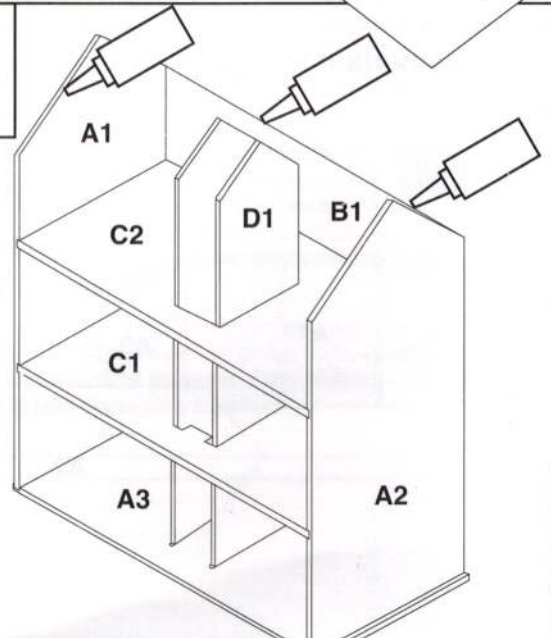

13

PVA

Locate rear roof panel (E2) and glue as shown. Use masking tape to hold panels in position while drying.

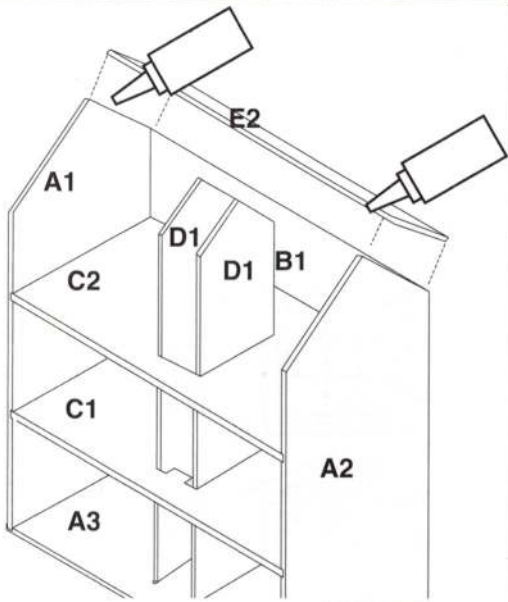

17

PVA

Use a set square to position windows

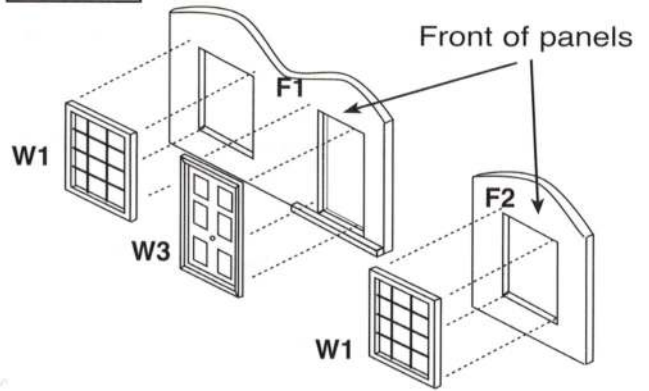

14

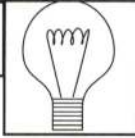

Light your dolls house now (See wiring instructions for full details).

15

PVA

Locate front roof panel (E1) and apply glue as shown.

Chamfered corners at front

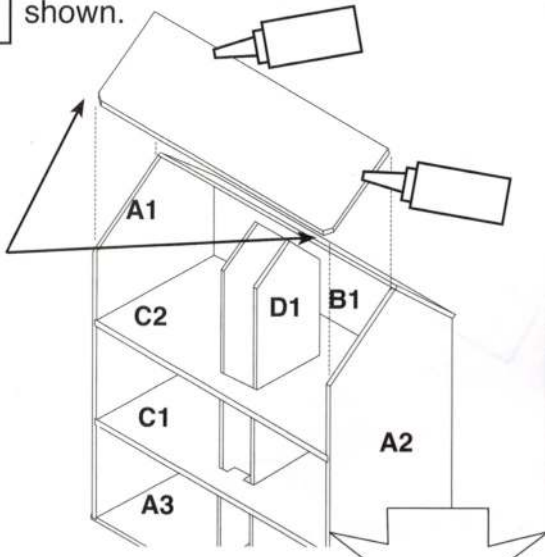

18

PVA

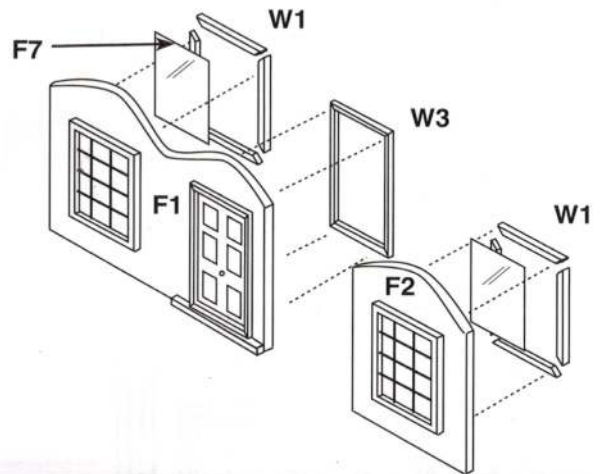

REPEAT FOR REST OF WINDOWS

16

Ensure carcass is square and leave to dry.

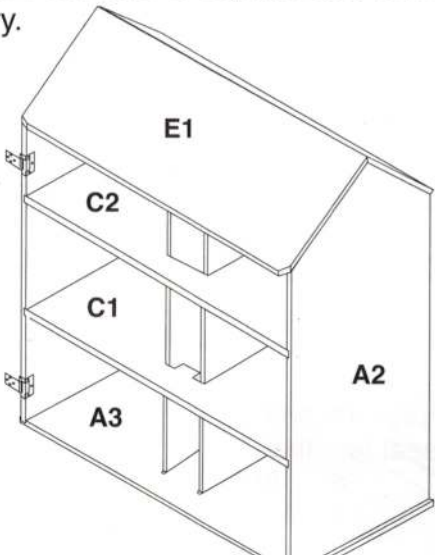

19

PVA

Apply glue and locate curved scotia (F10) and porticos (G1/W2) as shown.

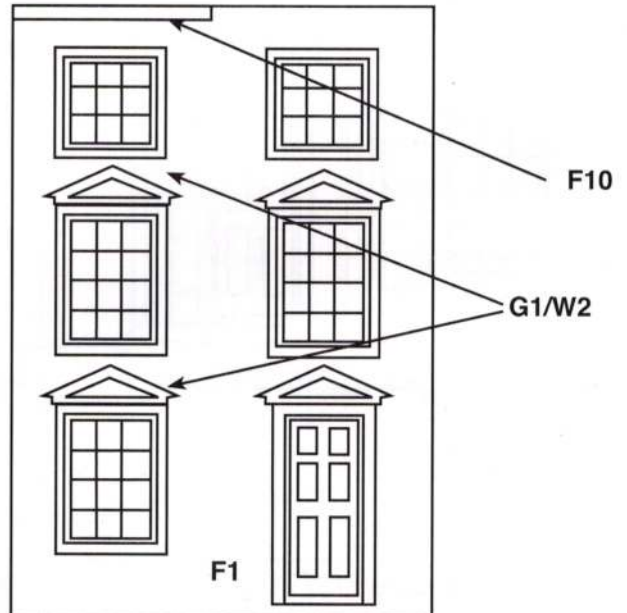

20



Glue Half Round Column (F13) onto Large Flat Column (F12). Use door step (F11) to correctly space the column assembly from the bottom, glue assembly in place as shown.

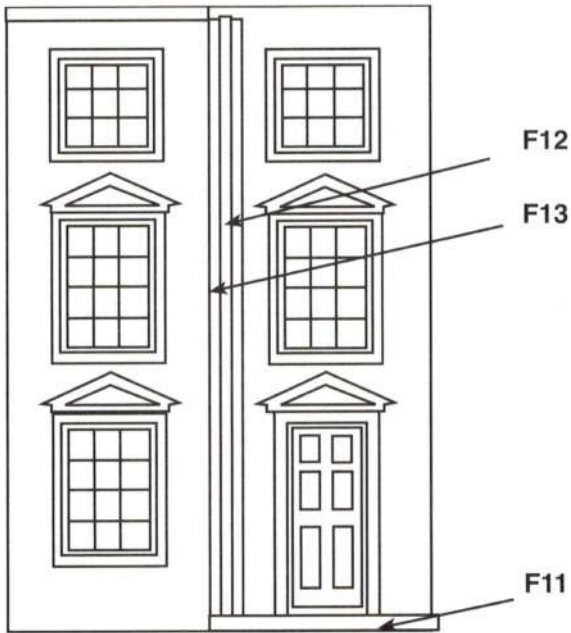

23



Glue F14 and F15 onto large front panel.

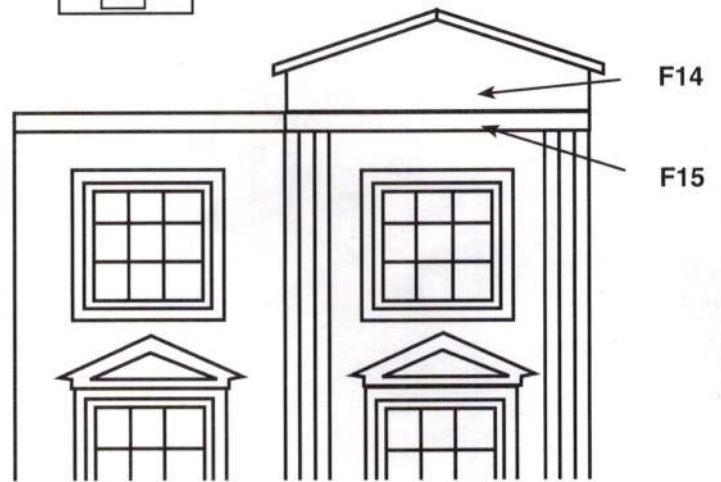

21



Repeat step 23. Allow second column assembly to over lap, this will cover join in opening panel.

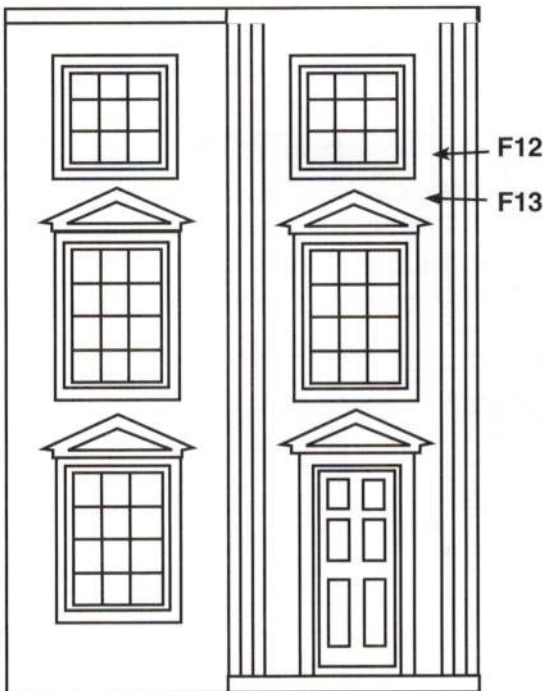

24



Apply glue and locate stairways (X1).

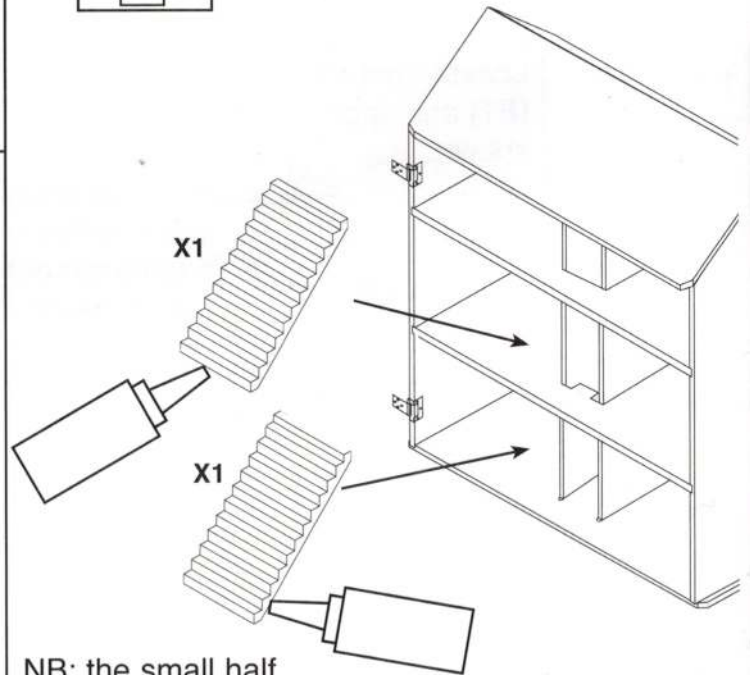

NB: the small half step is the top step.

22



F16

F14

F15

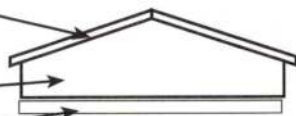

25



Apply glue to the top of the Chimney Stack (H2) (shaded). Locate Chimney Cap (H3) centrally. Apply glue to the bottom of the Chimney Pots (H4) and locate. Repeat for other chimney.

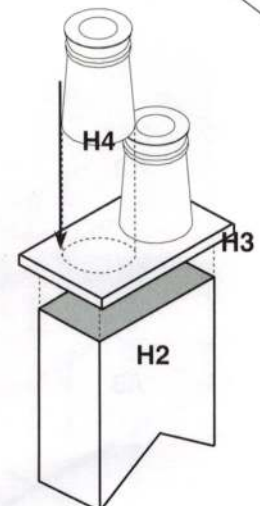

26

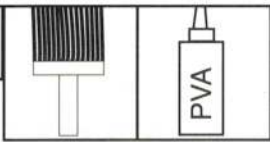

Glue roof paper using wallpaper paste. Glue chimneys to roof once roof paper is dry. (Note: a better bond is achieved by gluing chimneys to roof before papering, if you are prepared to cut out paper around chimneys.)



29



On Small Front Panel (F2), glue remaining Porticos (G1/W2) and Curved Scotia (F10) as shown, making sure they don't foul the large opening panel when doors are closed.

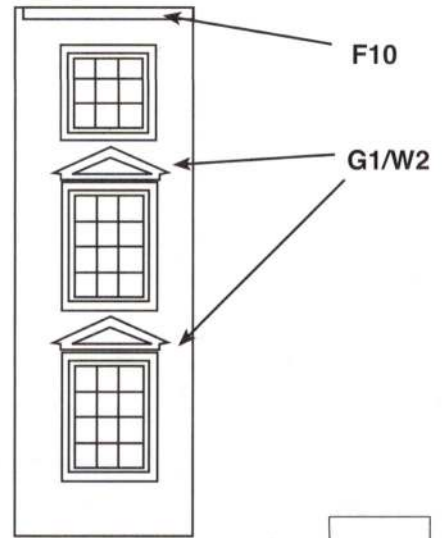

27



Mark and drill 1.5mm pilot holes then fit hinges (H1) to carcass.

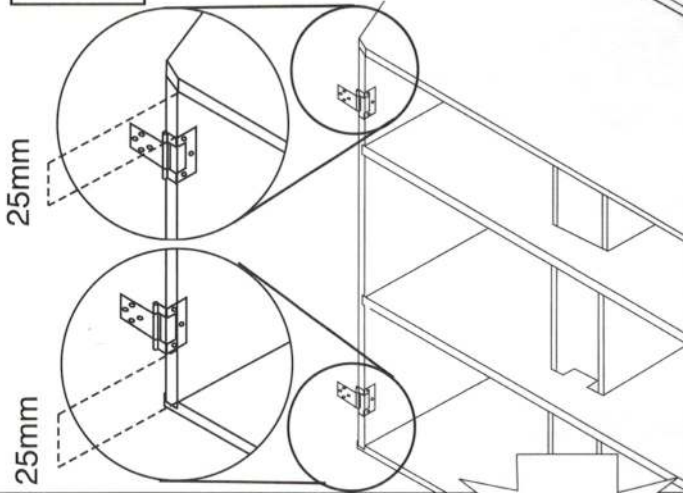

30



Apply glue to hole in door panel. Locate magnet (F18) and allow to dry. Put a small amount of water, ink or paint on magnet and close door. Open door and fit the striking plate where mark is. NB. To fit striking plate, drill 1.5mm pilot hole no deeper than 5mm and apply PVA glue into hole before fitting.

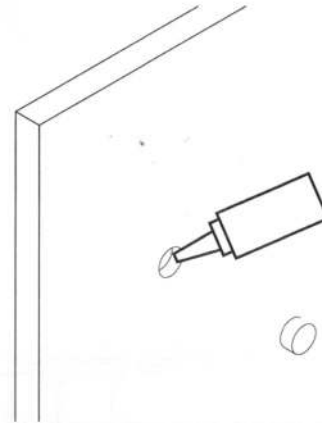

28



Offer Large Front Panel (F1) to carcass using Gap Guide (F19) to support it. Mark one hole through each hinge. Drill 1.5mm pilot holes and fit one screw in each hinge. Check door is square and moves freely, adjust if required. Repeat this step for (F2). Ensure both panels fit correctly. Mark, drill and fit all screws.

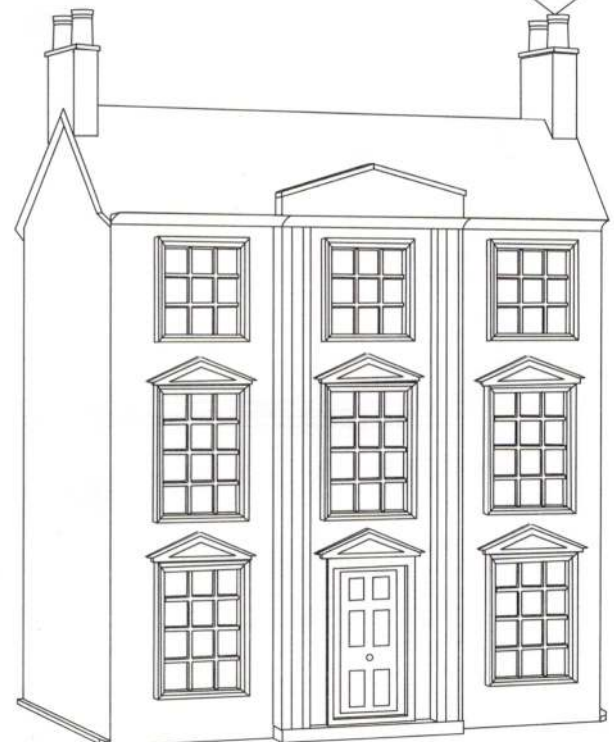
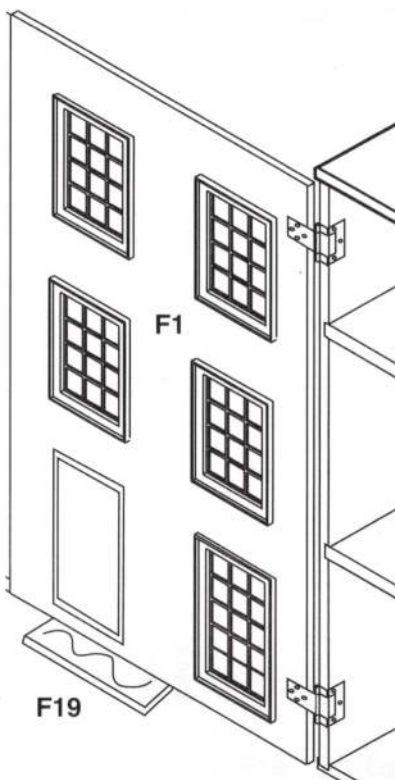

You have now completed your Classical Dolls House QuickStyle. We hope you are pleased with the result.

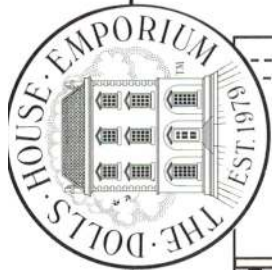

Diagrams to show fitting of a hanging light

Electrical Layout for Classical Dolls House QuickStyle

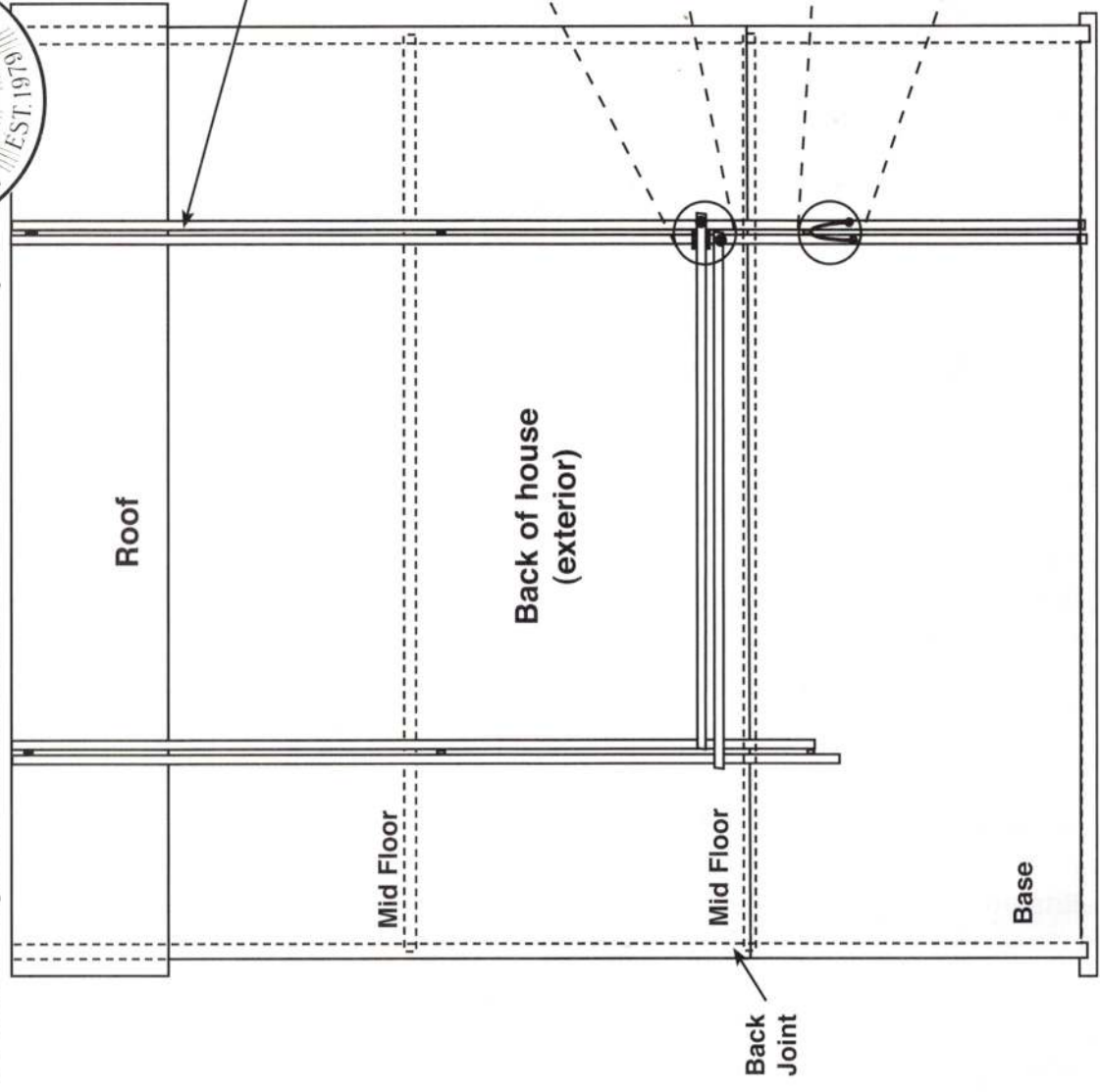

Bend copper tape around and underneath roof overhang giving some "slack"

Tape

Solder

1.5mm Hole

Solder

Wire from Light

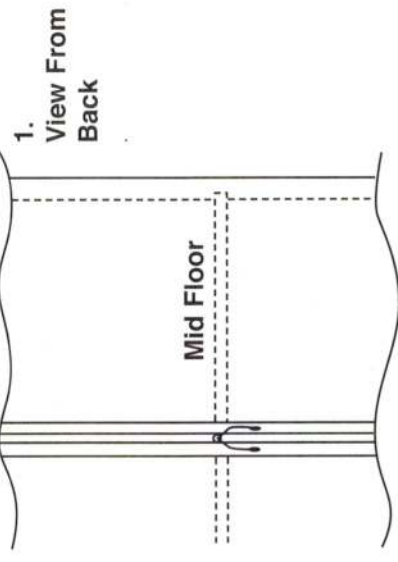

1. View From Back

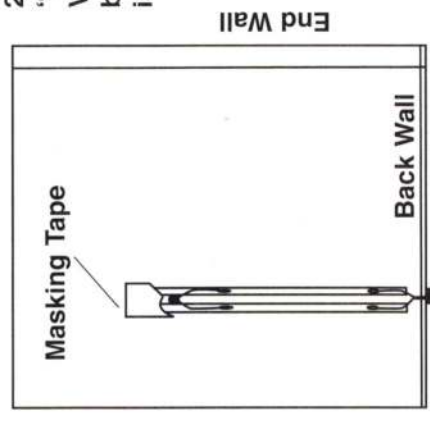

2. "Birds Eye View" of Floor, before flooring is laid

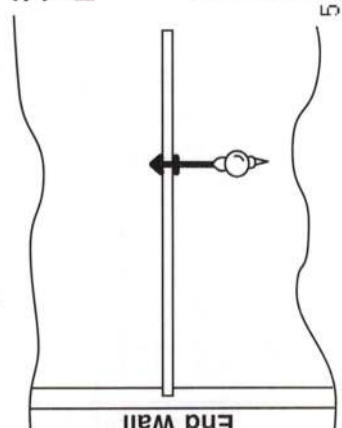

3. View From Front



Complete wiring instructions are given with our Wiring and Lighting Sets.